

1



CAP. 4
Cable ties
Fascette



- ◆ MATERIAL: NYLON 66(UL)
- ◆ FLAME CLASS :94V-2
- ◆ COLOR: NATURAL/BLACK
- ◆ UNIT:mm

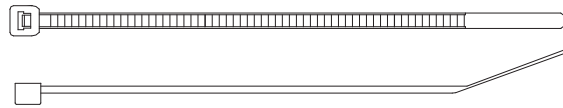

SELF-LOCKING TIES:

NEW PART NO	PART NO	APPROX LENGTH mm(in)	APPROX WIDTH mm(in)	MAX BUNDLE mm(in)	MIN. LOOP TENSILE STRENGTH kgs.(lbs.)	PACKAGE
MOSGT80M	YJ-80	80(3.15'')	2.5(0.10'')	17(0.67'')	8(18)	1000PCS
-----	YJ-98	98(3.86'')	2.5(0.10'')	22(0.87'')	8(18)	1000PCS
MOSGT100M	YJ-100	100(4.00'')	2.5(0.10'')	23(0.91'')	8(18)	1000PCS
MOSGT120M	YJ-120	120(4.72'')	2.5(0.10'')	30(1.18'')	8(18)	1000PCS
MOSGT140M	YJ-142S	142(5.59'')	2.5(0.10'')	36(1.42'')	8(18)	1000PCS
MOSGT160M	YJ-160	160(6.30'')	2.5(0.10'')	42(1.66'')	8(18)	1000PCS
-----	YJ-181	181(7.13'')	2.5(0.10'')	49(1.92'')	8(18)	1000PCS
MOSGT200M	YJ-203S	203(8.00'')	2.5(0.10'')	56(2.21'')	8(18)	1000PCS
-----	YJ-102	102(4.00'')	3.6(0.14'')	22(0.87'')	18(40)	500PCS
MOSGT120I	YJ-122	122(4.80'')	3.6(0.14'')	29(1.14'')	18(40)	500PCS
MOSGT140I	YJ-142	142(5.59'')	3.6(0.14'')	34(1.34'')	18(40)	1000PCS
-----	YJ-163	163(6.41'')	3.6(0.14'')	40(1.57'')	18(40)	500PCS
MOSGT180I	YJ-185	185(7.28'')	3.6(0.14'')	47(1.85'')	18(40)	500PCS
MOSGT200I	YJ-203	203(8.00'')	3.6(0.14'')	55(2.17'')	18(40)	500PCS
MOSGT250I	YJ-232	232(9.13'')	3.6(0.14'')	63(2.48'')	18(40)	500PCS
-----	YJ-263	263(10.35'')	3.6(0.14'')	73(2.87'')	18(40)	500PCS
MOSGT300I	YJ-295	295(11.61'')	3.6(0.14'')	83(3.27'')	18(40)	500PCS
-----	YJ-331	331(13.00'')	3.6(0.14'')	96(3.78'')	18(40)	500PCS
MOSGT370I	YJ-370	370(14.57'')	3.6(0.14'')	108(4.25'')	18(40)	500PCS
MOSGT120ST	YJ-115	115(4.53'')	4.8(0.19'')	29(1.15'')	23(50)	500PCS
MOSGT150ST	YJ-140	140(5.50'')	4.8(0.19'')	34(1.34'')	23(50)	500PCS
MOSGT160ST	YJ-162	162(6.38'')	4.8(0.19'')	42(1.66'')	23(50)	500PCS
MOSGT190ST	YJ-188	188(7.40'')	4.8(0.19'')	49(1.93'')	23(50)	500PCS
MOSGT200ST	YJ-201	201(8.00'')	4.8(0.19'')	53(2.08'')	23(50)	500PCS
MOSGT216ST	YJ-216	216(8.50'')	4.8(0.19'')	58(2.28'')	23(50)	500PCS
MOSGT250ST	YJ-242	242(9.53'')	4.8(0.19'')	66(2.60'')	23(50)	500PCS
MOSGT266ST	YJ-266	266(10.47'')	4.8(0.19'')	72(2.84'')	23(50)	500PCS
MOSGT300ST	YJ-292	292(11.50'')	4.8(0.19'')	82(3.23'')	23(50)	500PCS
-----	YJ-330	330(13.00'')	4.8(0.19'')	93(3.66'')	23(50)	500PCS
MOSGT370ST	YJ-368	368(14.49'')	4.8(0.19'')	106(4.17'')	23(50)	500PCS
-----	YJ-410	410(16.14'')	4.8(0.19'')	122(4.80'')	23(50)	500PCS
MOSGT430ST	-----	430(16.93'')	4.8(0.19'')	126(4.96'')	23(50)	500PCS
MOSGT450ST	YJ-450	450(17.72'')	4.8(0.19'')	135(5.31'')	23(50)	100PCS
MOSGT150HD	YJ-148	148(5.83'')	7.6(0.30'')	36(1.42'')	54(120)	100PCS
MOSGT200HD	YJ-182	182(7.17'')	7.6(0.30'')	46(1.81'')	54(120)	100PCS
-----	YJ-215	215(8.46'')	7.6(0.30'')	59(2.32'')	54(120)	100PCS
MOSGT250HD	YJ-254	254(10.00'')	7.6(0.30'')	71(2.80'')	54(120)	100PCS
MOSGT300HD	YJ-293	293(11.54'')	7.6(0.30'')	84(3.30'')	54(120)	100PCS
-----	YJ-332	332(13.00'')	7.6(0.30'')	95(3.74'')	54(120)	100PCS
MOSGT370HD	YJ-368L	368(14.49'')	7.6(0.30'')	109(4.29'')	54(120)	100PCS
-----	YJ-420	420(16.54'')	7.6(0.30'')	124(4.88'')	54(120)	100PCS
-----	YJ-470	470(18.50'')	7.6(0.30'')	140(5.51'')	54(120)	100PCS
-----	YJ-520	520(20.47'')	7.6(0.30'')	156(6.14'')	54(120)	100PCS
-----	YJ-178	178(7.00'')	9.0(0.35'')	45(1.76'')	80(175)	100PCS
-----	YJ-229	229(9.00'')	9.0(0.35'')	61(2.40'')	80(175)	100PCS
-----	YJ-280	280(11.00'')	9.0(0.35'')	77(3.03'')	80(175)	100PCS
-----	YJ-329	329(13.00'')	9.0(0.35'')	93(3.66'')	80(175)	100PCS
-----	YJ-382	382(15.00'')	9.0(0.35'')	110(4.33'')	80(175)	100PCS
-----	YJ-458	458(18.00'')	9.0(0.35'')	135(5.32'')	80(175)	100PCS
MOSGT530HD	YJ-530	530(20.87'')	9.0(0.35'')	155(6.10'')	80(175)	100PCS
-----	YJ-655	655(25.79'')	9.0(0.35'')	194(7.64'')	80(175)	100PCS
MOSGT780HD	YJ-780	780(30.71'')	9.0(0.35'')	234(9.21'')	80(175)	100PCS
MOSGT830HD	YJ-815	815(32.00'')	9.0(0.35'')	247(9.72'')	80(175)	100PCS

CABLE TIES

- ◆ MATERIAL: NYLON 66(UL)
- ◆ FLAME CLASS :94V-2
- ◆ COLOR: NATURAL/BLACK
- ◆ UNIT: mm

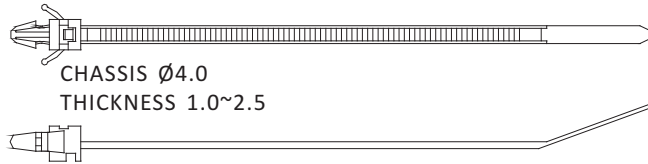

PUSH SELF-LOCKING TIES:

PART NO	APPROX LENGTH mm(in)	APPROX WIDTH mm(in)	MAX BUNDLE mm(in)	MIN. LOOP TENSILE STRENGTH kgs.(lbs.)	PACKAGE
MOSYJ123	123(4.84")	3.4(0.13")	25.4(1.00")	18.(40)	1000pcs

CABLE TIES

- ◆ MATERIAL: NYLON 66(UL)
- ◆ FLAME CLASS :94V-2
- ◆ COLOR: NATURAL/BLACK
- ◆ UNIT: mm

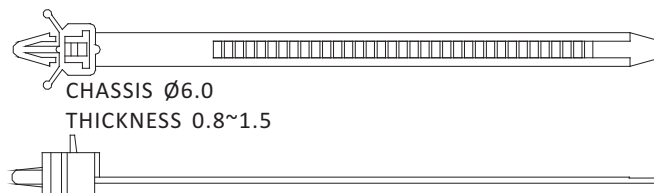

PUSH RELEASABLE TIES:

PART NO	APPROX LENGTH mm(in)	APPROX WIDTH mm(in)	MAX BUNDLE mm(in)	MIN. LOOP TENSILE STRENGTH kgs.(lbs.)	PACKAGE
MOSYJR151	151(6.00")	7.8(0.30")	37(1.45")	40(88)	100pcs
MOSYJR191	191(7.50")		49(1.92")		
MOSYJR231	231(9.00")		62(2.44")		

CABLE TIES

- ◆ MATERIAL: NYLON 66(UL)
- ◆ FLAME CLASS :94V-2
- ◆ COLOR: NATURAL
- ◆ UNIT: mm

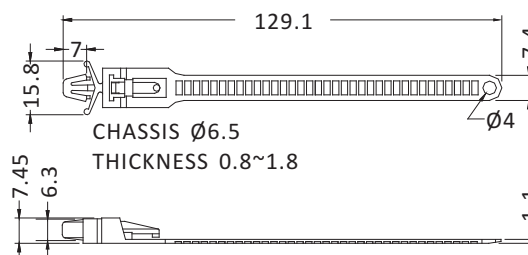
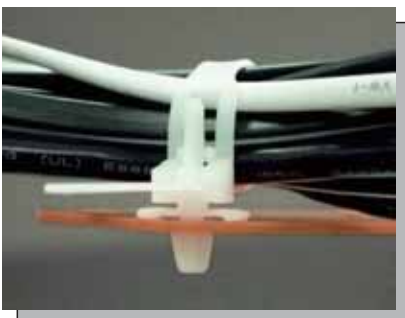

PART NO	PACKAGE
MOSKYCB129	250

- ◆ MATERIAL: NYLON 66(UL)
- ◆ FLAME CLASS :94V-2
- ◆ COLOR: NATURAL/BLACK
- ◆ UNIT:mm

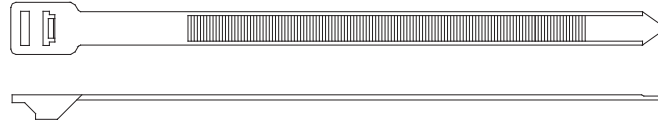

PART NO	APPROX LENGTH mm(in)	APPROX WIDTH mm(in)	MAX BUNDLE mm(in)	MIN. LOOP TENSILE STRENGTH kgs.(lbs.)	PACKAGE
MOSYJ228	228(9.00")	12.7(0.50")	54(2.12")	114(250)	100pcs
MOSYJ256	256(10.00")		62(2.44")		
MOSYJ279	279(11.00")		70(2.75")		
MOSYJ305	305(12.00")		78(3.07")		
MOSYJ328	328(13.00")		86(3.38")		
MOSYJ355	355(14.00")		94(3.70")		
MOSYJ380	380(15.00")		102(4.00")		
MOSYJ405	405(16.00")		110(4.33")		
MOSYJ430	430(17.00")		118(4.64")		
MOSYJ455	455(18.00")		127(5.00")		
MOSYJ485	485(19.00")		135(5.31")		
MOSYJ510	510(20.00")		143(5.62")		
MOSYJ534	534(21.00")		151(5.94")		
MOSYJ560	560(22.00")		159(6.25")		
MOSYJ585	585(23.00")		167(6.57")		
MOSYJ610	610(24.00")		175(6.88")		
MOSYJ635	635(25.00")		183(7.20")		
MOSYJ660	660(26.00")		191(7.51")		
MOSYJ685	685(27.00")		199(7.83")		
MOSYJ710	710(28.00")		207(8.14")		
MOSYJ735	735(29.00")		215(8.46")		
MOSYJ760	760(30.00")		224(8.81")		
MOSYJ790	790(31.00")		232(9.13")		
MOSYJ813	813(32.00")		243(9.57")		
MOSYJ915	915(36.00")	274(10.79")			
MOSYJ1042	1042(41.00")	314(12.36")			
MOSYJ1168	1068(46.00")	354(13.94")			

CABLE TIES

- ◆ MATERIAL: NYLON 66(UL)
- ◆ FLAME CLASS :94V-2
- ◆ COLOR: NATURAL/BLACK
- ◆ UNIT:mm

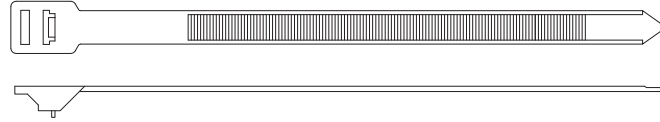

RELEASABLE TIES:

PART NO	APPROX LENGTH mm(in)	APPROX WIDTH mm(in)	MAX BUNDLE mm(in)	MIN. LOOP TENSILE STRENGTH kgs.(lbs.)	PACKAGE
MOSYJR228	228(9.00")	12.7(0.50")	54(2.12")	114(250)	100pcs
MOSYJR256	256(10.00")		62(2.44")		
MOSYJR279	279(11.00")		70(2.75")		
MOSYJR305	305(12.00")		78(3.07")		
MOSYJR328	328(13.00")		86(3.38")		
MOSYJR355	355(14.00")		94(3.70")		
MOSYJR380	380(15.00")		102(4.00")		
MOSYJR405	405(16.00")		110(4.33")		
MOSYJR430	430(17.00")		118(4.64")		
MOSYJR455	455(18.00")		127(5.00")		
MOSYJR485	485(19.00")		135(5.31")		
MOSYJR510	510(20.00")		143(5.62")		
MOSYJR534	534(21.00")		151(5.94")		
MOSYJR560	560(22.00")		159(6.25")		
MOSYJR585	585(23.00")		167(6.57")		
MOSYJR610	610(24.00")		175(6.88")		
MOSYJR635	635(25.00")		183(7.20")		
MOSYJR660	660(26.00")		191(7.51")		
MOSYJR685	685(27.00")		199(7.83")		
MOSYJR710	710(28.00")		207(8.14")		
MOSYJR735	735(29.00")		215(8.46")		
MOSYJR760	760(30.00")		224(8.81")		
MOSYJR790	790(31.00")		232(9.13")		
MOSYJR813	813(32.00")		243(9.57")		
MOSYJR915	915(36.00")	274(10.79")			
MOSYJR1042	1042(41.00")	314(12.36")			
MOSYJR1168	1168(46.00")	354(13.94")			

- ◆ MATERIAL: NYLON 66(UL)
- ◆ FLAME CLASS :94V-2
- ◆ COLOR: NATURAL/BLACK
- ◆ UNIT: mm

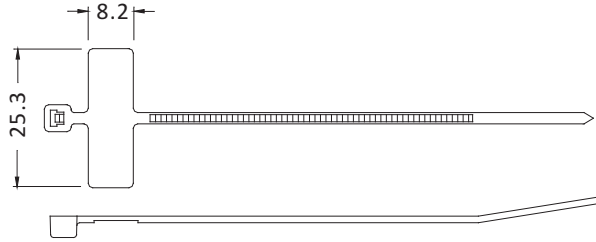

MARKER TIES:

PART NO	APPROX LENGT mm(in)	APPROX WIDTH mm(in)	MAX BUNDLE mm(in)	MIN. LOOP TENSILE STRENGTH kgs.(lbs.)	PACKAGE
MOSYJ98X	100(4.00")	2.5(0.10")	22.(0.87")	8(18)	500pcs

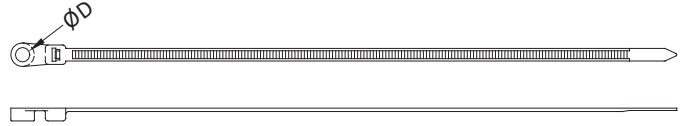

CLAMP MOUNTING TIES:

PART NO	APPROX LENGTH mm(in)	D	APPROX WIDTH mm(in)	MAX BUNDLE mm(in)	MIN. LOOP TENSILE STRENGTH kgs.(lbs.)	PACKAGE
MOSYJ110	110(4.33")	3.2	2.8(0.11")	23(0.91")	10(22)	500pcs
MOSYJ156	156(6.14")	4.2	3.6(0.14")	35(1.38")	18(40)	1000pcs
MOSYJ205	205(8.00")	5.4	4.8(0.19")	51(2.01")	23(50)	
MOSYJ255	255(10.00")			67(2.64")		
MOSYJ304	304(12.00")			83(3.27")		
MOSYJ356	356(14.00")			101(3.98")		
MOSYJ406	406(16.00")	6.4	7.6(0.30")	118(4.64")	54(120)	500pcs
MOSYJ230	230(9.00")			58(2.28")		
MOSYJ306	306(12.00")			84(3.31")		
MOSYJ381	381(15.00")			108(4.25")		
MOSYJ460	460(18.00")	6.4	7.6(0.30")	133(5.24")	54(120)	100pcs
MOSYJ535	535(21.00")			155(6.10")		

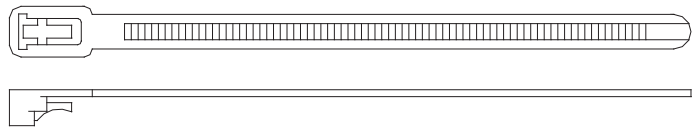

RELEASABLE TIES:

PART NO	APPROX LENGTH mm(in)	APPROX WIDTH mm(in)	MAX BUNDLE mm(in)	MIN. LOOP TENSILE STRENGTH kgs.(lbs.)	PACKAGE
MOSYJR150	150(5.90")	7.5(0.295")	39(1.54")	23(50)	100pcs
MOSYJR200	200(7.87")		56(2.21")		
MOSYJR250	250(9.84")		72(2.83")		

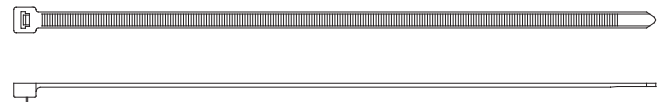

RELEASABLE TIES:

PART NO	APPROX LENGT mm (in)	APPROX WIDTH mm(in)	MAX BUNDLE mm(in)	MIN. LOOP TENSILE STRENGTH kgs.(lbs.)	PACKAGE
MOSYJR300	300(11.81")	7.6(0.30")	86(3.38")	23(50)	100pcs
MOSYJR350	350(13.87")		102(4.02")		
MOSYJR400	400(15.75")		118(4.65")		
MOSYJR655	655(25.79")	9.0(0.35")	194(7.64")	80(175)	
MOSYJR780	780(30.71")		234(9.21")		
MOSYJR815	815(32.00")		247(9.72")		

CABLE TIES

- ◆ MATERIAL: NYLON 66(UL)
- ◆ FLAME CLASS :94V-2
- ◆ COLOR: NATURAL
- ◆ UNIT: mm

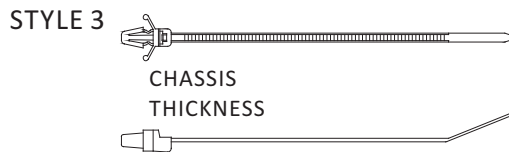
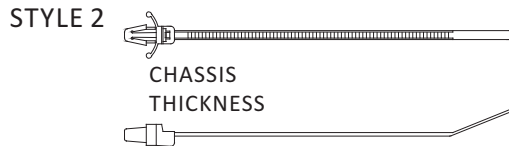

PART NO	Approx Length mm(in)	Approx Width mm(in)	Max. Bundle Dia mm(in)	Min. LOOP Tensile Strength kgs.(lbs.)	Hole Diameter CHASSIS	Max. Panel THICKNESS	STYLE	PACKAGE
MOSGTP130ST	132(5.12)	4.8(0.19)	25(0.98)	22.2(50)	6.4(0.252)	3.2(0.126)	3	1000
MOSGTP170ST	175(6.69)		38(1.50)					
MOSGTP190ST	200(7.68)		45(1.77)					
MOSGTP110M	110(4.33)	2.5(0.10)	22(0.87)	8.1(18)	4.8~5.0 (0.189)~(0.197)	0.8~2.4 (0.03)~(0.09)	2	
MOSGTP110MA								
MOSGTP130I	130(5.12)	3.2(0.13)	28(1.10)	13.6(30)	4.0(0.157)	1.0~2.0	3	
MOSGTP150I	150(5.91)	3.6(0.14)	32(1.26)		5.2(0.205)	1.0~2.8	1	
MOSGTP200ST	200(7.87)	4.8(0.19)	46(1.81)		22.2(50)	6.3(0.248)		3.6(0.141)
Releasable Cable Tie								
MOSGTRP130I	130(5.12)	3.2(0.13)	28(1.10)	13.6(30)			3	1000

STRAP TIES

- ◆ MATERIAL: PE/NYLON 66 (UL)
- ◆ FLAME CLASS :94V-2
- ◆ COLOR: NATURAL/BLACK
- ◆ UNIT: mm

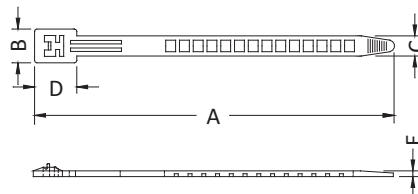

PART NO	A	B	C	D	E	PACKAGE
MOSST1SN	157	15.0	8.6	18.3	1.0	500
MOSST1	157	14.7	8.6	18.3	1.5	
MOSST4	205	15.0	8.6	18.3	1.7	
MOSST5	125	13.0	7.5	16.0	1.45	
MOSST5NS	125	13.0	7.5	16.0	1.0	
MOSST11N	300	15.0	8.6	18.3	1.7	

- ◆ MATERIAL:PE
- ◆ COLOR:NATURAL/BLACK
- ◆ UNIT:mm

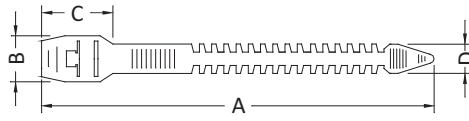

PART NO	A	B	C	D	PACKAGE
MOSST2	135.0	15.8	21.4	10.0	500
MOSST3	140.0	15.4	24.5	10.0	

STRAP TIES

- ◆ MATERIAL:TPE
- ◆ COLOR:BLUE
- ◆ UNIT:mm

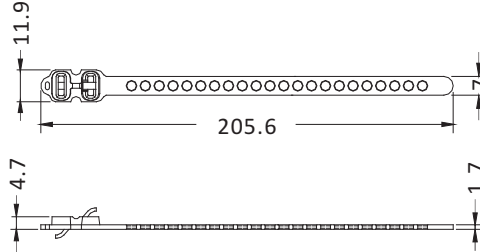

PART NO	PACKAGE
MOSST6	250

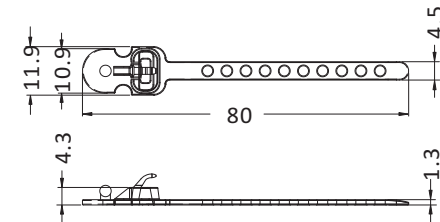

PART NO	PACKAGE
MOSST13	500

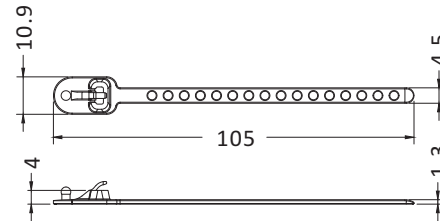

PART NO	PACKAGE
MOSST15	500

STRAP TIES

- ◆ MATERIAL:PE
- ◆ COLOR:NATURAL
- ◆ UNIT:mm

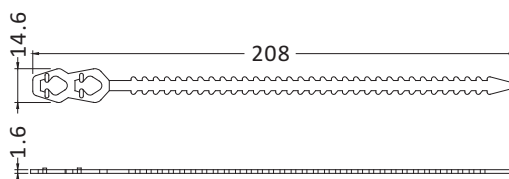

PART NO	PACKAGE
MOSST7	500

STRAP TIES

- ◆ MATERIAL:PE
- ◆ COLOR:BLACK
- ◆ UNIT:mm

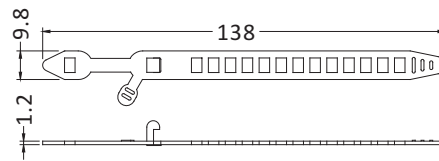

PART NO	PACKAGE
MOSST8	500

STRAP TIES

- ◆ MATERIAL:NYLON 66 (UL)
- ◆ FLAME CLASS :94V-2
- ◆ COLOR:BLACK
- ◆ UNIT:mm

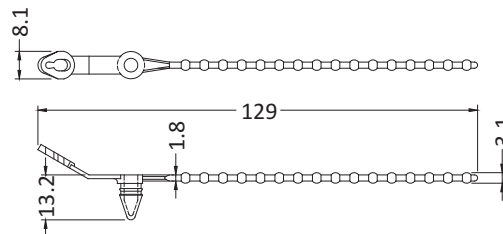
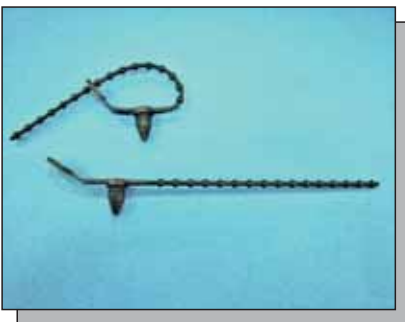

PART NO	PACKAGE
MOSST9	500

STRAP TIES

- ◆ MATERIAL:PE
- ◆ COLOR:NATURAL
- ◆ UNIT:mm

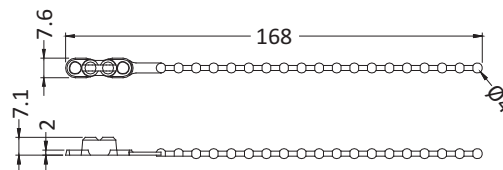

PART NO	PACKAGE
MOSSTO166	500

STRAP TIES

- ◆ MATERIAL:NYLON 66(UL)
- ◆ FLAME CLASS :94V-2/94V-0
- ◆ COLOR:NATURAL
- ◆ UNIT:mm

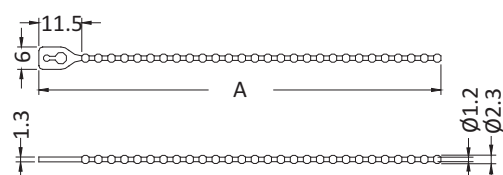

PART NO	A	PACKAGE
MOSGTB70	70.0	1000
MOSGTB100	112.0	

- ◆ MATERIAL: NYLON 66 (UL)
- ◆ FLAME CLASS : 94V-2
- ◆ COLOR: BLACK
- ◆ UNIT: mm

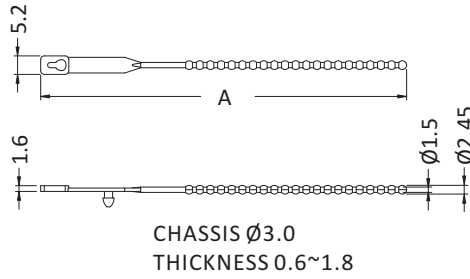

PART NO	A	PACKAGE
MOSGTB85	85.0	1000
MOSGTB103	103.0	

CABLE TIES

- ◆ MATERIAL: NYLON 66 (UL)
- ◆ FLAME CLASS : 94V-2
- ◆ COLOR: BLACK
- ◆ UNIT: mm

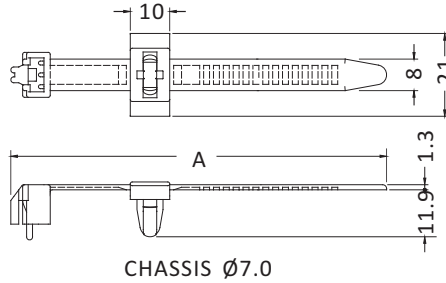
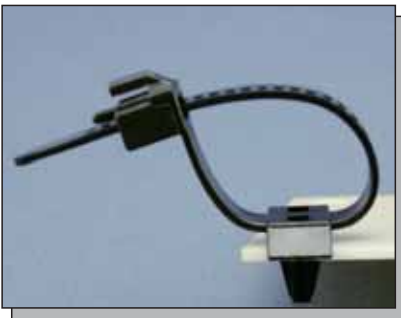

PART NO	A	PACKAGE
MOSSTC115	115.3	200
MOSSTC175	175.0	

CABLE TIES

- ◆ MATERIAL: NYLON 66 (UL)
- ◆ FLAME CLASS : 94V-2
- ◆ COLOR: BLACK
- ◆ UNIT: mm

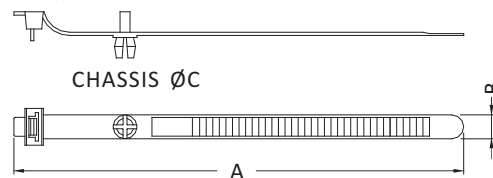

PART NO	A	B	C	PACKAGE
MOSSTC171	171.2	9.1	Ø7.0	100
MOSSTC172	171.0	6.5	Ø5.5	
MOSSTC174	220.0	9.1	Ø7.0	

CABLE TIES

- ◆ MATERIAL: NYLON 66 (UL)
- ◆ FLAME CLASS : 94V-2
- ◆ COLOR: BLACK
- ◆ UNIT: mm

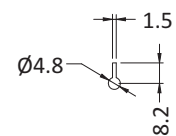
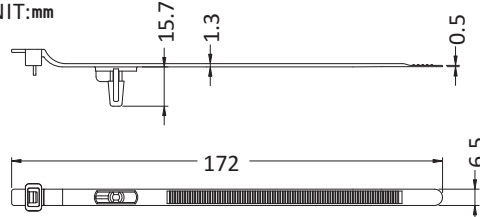

MOUNTING HOLE
THICKNESS MAX 3.8

PART NO	PACKAGE
MOSSTC173	200

CABLE TIES

- ◆ MATERIAL: NYLON 66 (UL)
- ◆ FLAME CLASS: 94V-2
- ◆ COLOR: BLACK
- ◆ UNIT: mm

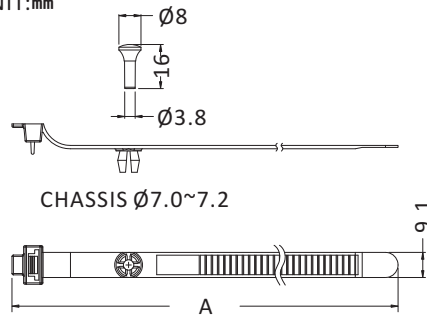

PART NO	A	PACKAGE
MOSSTC121	121.0	100
MOSSTC176	171.2	

CABLE TIES

- ◆ MATERIAL: LDPE
- ◆ COLOR: BLACK
- ◆ UNIT: mm

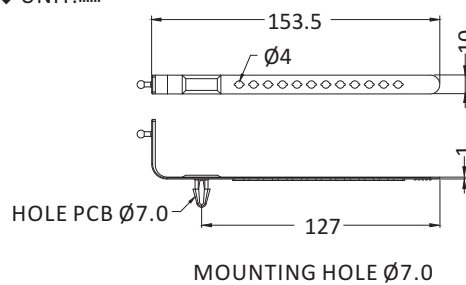

PART NO	PACKAGE
MOSSTCA161	500

CABLE TIES

- ◆ MATERIAL: NYLON 66 (UL)
- ◆ FLAME CLASS: 94V-2
- ◆ COLOR: BLACK/WHITE
- ◆ UNIT: mm

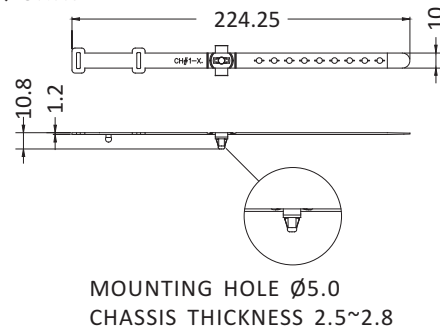

PART NO	PACKAGE
MOSSTCA224	500

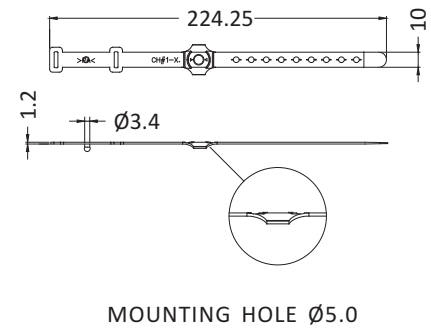

PART NO	PACKAGE
MOSSTCA225	500

CABLE TIES

- ◆ MATERIAL: NYLON 66 (UL)
- ◆ FLAME CLASS: 94V-2
- ◆ COLOR: BLACK
- ◆ UNIT: mm

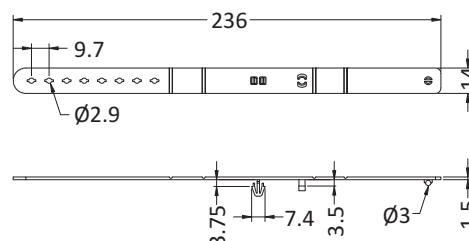

PART NO	PACKAGE
MOSSTCA235	500



- ◆ MATERIAL: NYLON 66(UL)
- ◆ FLAME CLASS :94V-2
- ◆ COLOR: BLACK
- ◆ UNIT: mm

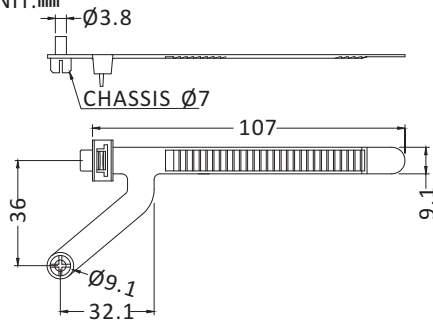

PART NO	PACKAGE
MOSSTCL100	100

STRAP TIES



- ◆ MATERIAL: NYLON 66(UL)
- ◆ FLAME CLASS :94V-2
- ◆ COLOR: NATURAL
- ◆ UNIT: mm

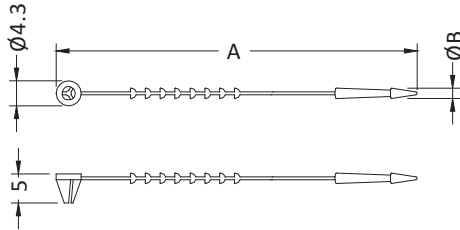

PART NO	A	B	PACKAGE
MOSLOCK145	145	1.8	1000
MOSLOCK200	200	2.0	

STRAP TIES



- ◆ MATERIAL: PP
- ◆ COLOR: NATURAL
- ◆ UNIT: mm

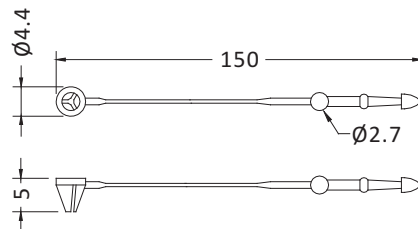

PART NO	PACKAGE
MOSLOCK150	1000

A.G.P CARD HOLDER

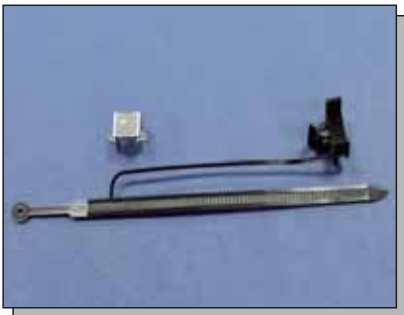

- ◆ MATERIAL: NYLON 66(UL)
- ◆ FLAME CLASS :94V-2
- ◆ COLOR: BLACK
- ◆ AGP-1B MATERIAL: STEEL
- ◆ UNIT: mm

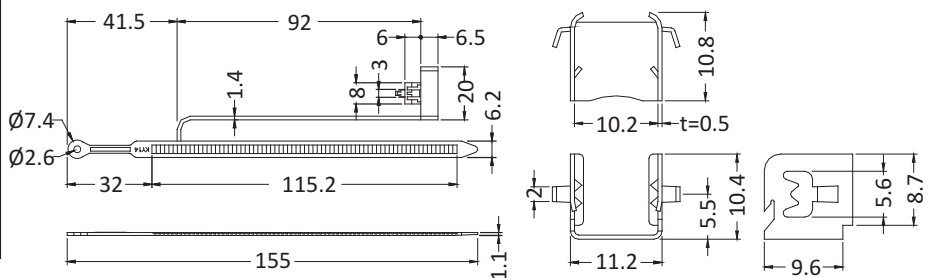

PART NO
MOSAGP1A

PART NO
MOSAGP1B

CABLE MOUNT



- ◆ MATERIAL: NYLON 66(UL)
- ◆ FLAME CLASS :94V-2
- ◆ COLOR:BLACK
- ◆ UNIT:mm

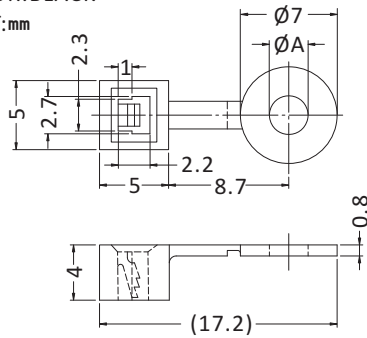

PART NO	ØA	PACKAGE
MOSASUS1	2.8	2000
MOSASUS3	3.1	

CABLE TIES



- ◆ MATERIAL:SUS316
- ◆ COLOR:NATURAL
- ◆ UNIT:mm

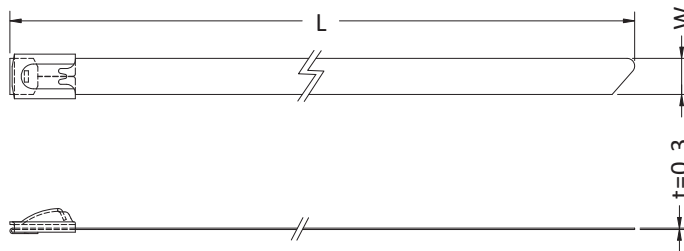

SELF-LOCKING TIES:

PART NO	MAX BUNDLE mm(in)	APPROX LENGTH mm(in)	APPROX WIDTH mm(in)	MIN. LOOP TENSILE STRENGTH kgs.(lbs.)	PACKAGE
MOSSTB152S	25(1.00'')	152(6.00'')	4.5(0.177'')	45.3(100)	100PCS
MOSSTB200S	50(2.00'')	200(8.00'')	4.5(0.177'')	45.3(100)	100PCS
MOSSTB360S	102(4.00'')	360(14.0'')	4.5(0.177'')	45.3(100)	100PCS
MOSSTB520S	152(6.00'')	520(20.0'')	4.5(0.177'')	45.3(100)	100PCS
MOSSTB680S	203(8.00'')	680(27.0'')	4.5(0.177'')	45.3(100)	100PCS
MOSSTB840S	254(10.0'')	840(33.0'')	4.5(0.177'')	45.3(100)	100PCS
MOSSTB1050S	318(12.5'')	1050(41.0'')	4.5(0.177'')	45.3(100)	50PCS

PART NO	MAX BUNDLE mm(in)	APPROX LENGTH mm(in)	APPROX WIDTH mm(in)	MIN. LOOP TENSILE STRENGTH kgs.(lbs.)	PACKAGE
MOSSTB152M	25(1.00'')	152(6.00'')	8.0(0.315'')	113.3(250)	100PCS
MOSSTB200M	50(2.00'')	200(8.00'')	8.0(0.315'')	113.3(250)	100PCS
MOSSTB360M	102(4.00'')	360(14.0'')	8.0(0.315'')	113.3(250)	100PCS
MOSSTB520M	152(6.00'')	520(20.0'')	8.0(0.315'')	113.3(250)	100PCS
MOSSTB680M	203(8.00'')	680(27.0'')	8.0(0.315'')	113.3(250)	100PCS
MOSSTB840M	254(10.0'')	840(33.0'')	8.0(0.315'')	113.3(250)	100PCS
MOSSTB1050M	318(12.5'')	1050(41.0'')	8.0(0.315'')	113.3(250)	50PCS

PART NO	MAX BUNDLE mm(in)	APPROX LENGTH mm(in)	APPROX WIDTH mm(in)	MIN. LOOP TENSILE STRENGTH kgs.(lbs.)	PACKAGE
MOSSTB290L	80(3.10'')	290(11.0'')	12.0(0.472'')	272.0(600)	50PCS
MOSSTB360L	102(4.00'')	360(14.0'')	12.0(0.472'')	272.0(600)	50PCS
MOSSTB430L	121(4.70'')	430(17.0'')	12.0(0.472'')	272.0(600)	50PCS
MOSSTB520L	152(6.00'')	520(20.0'')	12.0(0.472'')	272.0(600)	50PCS
MOSSTB600L	175(6.80'')	600(24.0'')	12.0(0.472'')	272.0(600)	50PCS
MOSSTB680L	203(8.00'')	680(27.0'')	12.0(0.472'')	272.0(600)	50PCS
MOSSTB750L	230(8.70'')	750(30.0'')	12.0(0.472'')	272.0(600)	50PCS
MOSSTB840L	254(10.0'')	840(33.0'')	12.0(0.472'')	272.0(600)	50PCS
MOSSTB910L	273(10.7'')	910(36.0'')	12.0(0.472'')	272.0(600)	25PCS
MOSSTB1000L	302(11.9'')	1000(39.0'')	12.0(0.472'')	272.0(600)	25PCS
MOSSTB1070L	325(12.8'')	1070(42.0'')	12.0(0.472'')	272.0(600)	25PCS
MOSSTB1200L	351(13.8'')	1200(47.0'')	12.0(0.472'')	272.0(600)	25PCS

- ◆ MATERIAL:SUS316
- ◆ COLOR:NATURAL
- ◆ UNIT:mm

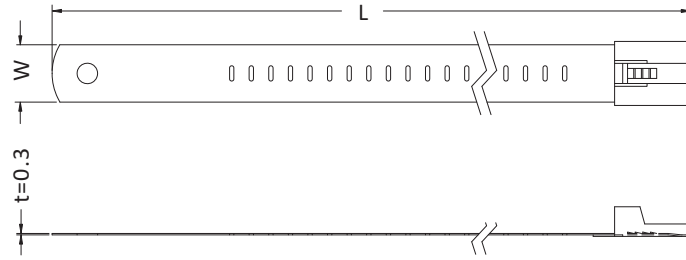
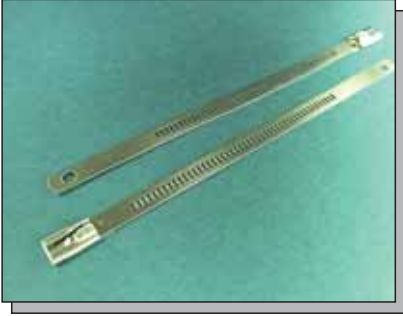

SELF-LOCKING TIES:

PART NO	MAX BUNDLE mm(in)	APPROX LENGTH mm(in)	APPROX WIDTH mm(in)	MIN. LOOP TENSILE STRENGTH kgs.(lbs.)	PACKAGE
MOSSTL150S	22(0.86")	150(5.90")	7.0(0.28")	113.4(250)	100PCS
MOSSTL195S	45(1.70")	195(8.00")	7.0(0.28")	113.4(250)	100PCS
MOSSTL255S	64(2.50")	255(10.0")	7.0(0.28")	113.4(250)	100PCS
MOSSTL335S	89(3.50")	335(13.0")	7.0(0.28")	113.4(250)	100PCS
MOSSTL490S	139(5.40")	490(19.0")	7.0(0.28")	113.4(250)	100PCS
MOSSTL635S	185(7.20")	635(25.0")	7.0(0.28")	113.4(250)	100PCS

PART NO	MAX BUNDLE mm(in)	APPROX LENGTH mm(in)	APPROX WIDTH mm(in)	MIN. LOOP TENSILE STRENGTH kgs.(lbs.)	PACKAGE
MOSSTL150M	22(0.86")	150(5.90")	12.0(0.472")	113.4(250)	100PCS
MOSSTL195M	45(1.70")	195(8.00")	12.0(0.472")	113.4(250)	100PCS
MOSSTL255M	64(2.50")	255(10.0")	12.0(0.472")	113.4(250)	100PCS
MOSSTL335M	89(3.50")	335(13.0")	12.0(0.472")	113.4(250)	100PCS
MOSSTL490M	139(5.40")	490(19.0")	12.0(0.472")	113.4(250)	100PCS
MOSSTL635M	185(7.20")	635(25.0")	12.0(0.472")	113.4(250)	100PCS

HANDLE GRIPS

- ◆ MATERIAL:HDPE
- ◆ COLOR:WHITE
- ◆ UNIT:mm

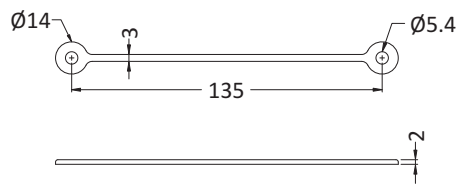
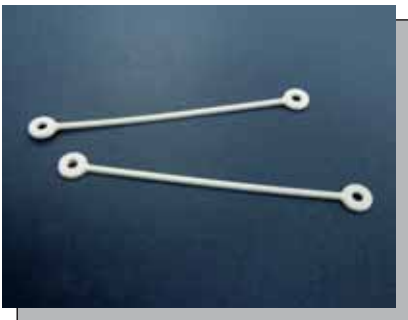

PART NO	PACKAGE
MOSSFA1	2000

PACKING FASTENERS

- ◆ MATERIAL: PP
- ◆ COLOR:NATURAL
- ◆ UNIT:mm

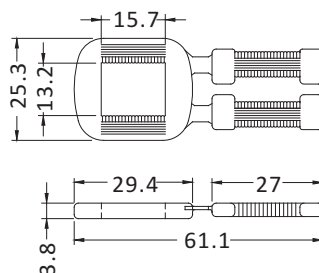

PART NO	PACKAGE
MOSCTBX1	250

CABLE TIE MOUNT



- ◆ MATERIAL: NYLON 66 (UL)
- ◆ FLAME CLASS :94V-2
- ◆ COLOR:NATURAL
- ◆ UNIT:mm

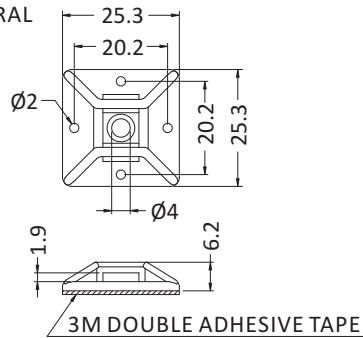

PART NO	PACKAGE
MOSCM1	500

CABLE TIE MOUNT



- ◆ MATERIAL: NYLON 66 (UL)
- ◆ FLAME CLASS:94V-2
- ◆ COLOR:NATURAL
- ◆ UNIT:mm

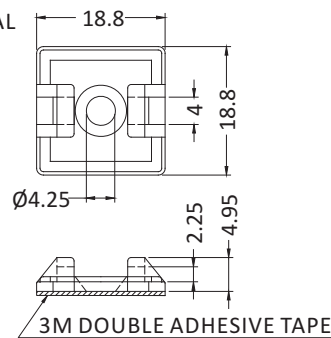

PART NO	PACKAGE
MOSCM18	1000

CABLE TIE MOUNT



- ◆ MATERIAL: NYLON 66 (UL)
- ◆ FLAME CLASS :94V-2
- ◆ COLOR:NATURAL
- ◆ UNIT:mm

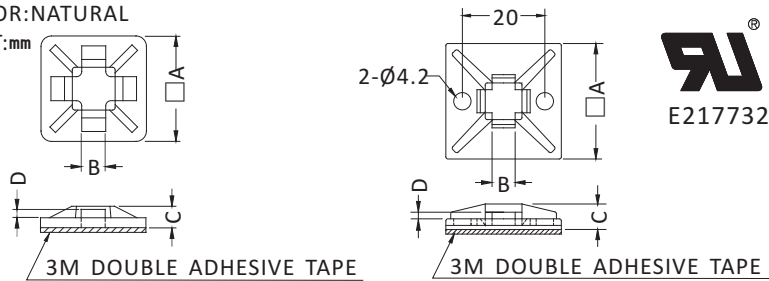

PART NO	A	B	C	D	PACKAGE	UL
MOSCM13	13.0	3.2	3.2	1.3	1000	UL
MOSCM16	16.0	3.8	4.0	1.5		
MOSCM19	19.1	4.0	4.0	1.6	500	UL
MOSCM19L	19.5	5.0	4.8	1.7		
MOSCM20	20.0	4.8	4.2	1.6		UL
MOSCM28S	28.0	5.6	5.2	1.6	250	

CABLE TIE MOUNT



- ◆ MATERIAL: NYLON 66 (UL)
- ◆ FLAME CLASS :94V-2
- ◆ COLOR:NATURAL
- ◆ UNIT:mm

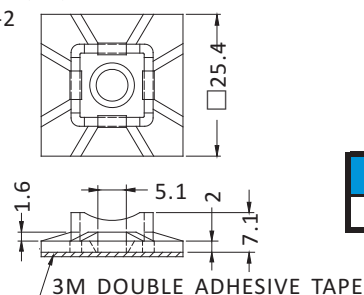

PART NO	PACKAGE
MOSCM25	500

CABLE TIE MOUNT

- ◆ MATERIAL: NYLON 66 (UL)
- ◆ FLAME CLASS : 94V-2
- ◆ COLOR: NATURAL
- ◆ UNIT: mm

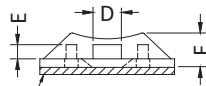
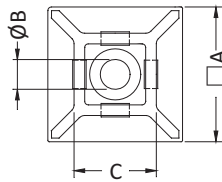
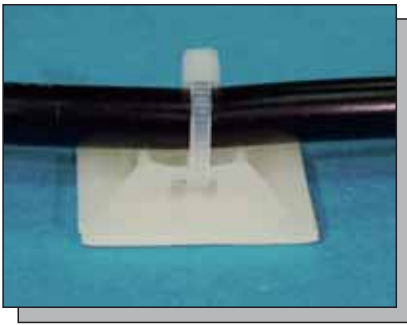

3M DOUBLE ADHESIVE TAPE

PART NO	A	B	C	D	E	F	PACKAGE
MOSCM19S	19.0	4.0	11.6	4.0	1.9	5.0	500
MOSCM28	27.8	5.6	13.2	5.6	2.0	5.5	250

CABLE TIE MOUNT

- ◆ MATERIAL: NYLON 66 (UL)
- ◆ FLAME CLASS: 94V-2
- ◆ COLOR: NATURAL/BLACK
- ◆ UNIT: mm

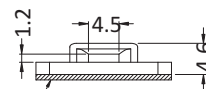
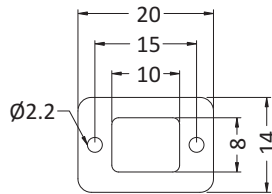

3M DOUBLE ADHESIVE TAPE

PART NO	PACKAGE
MOSCM29	1000

CABLE TIE MOUNT

- ◆ MATERIAL: NYLON 66 (UL)
- ◆ FLAME CLASS: 94V-2
- ◆ COLOR: NATURAL
- ◆ UNIT: mm

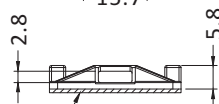
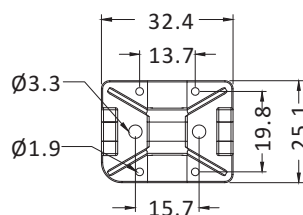

3M DOUBLE ADHESIVE TAPE

PART NO	PACKAGE
MOSCM30	1000

CABLE TIE MOUNT



- ◆ MATERIAL: NYLON 66 (UL)
- ◆ FLAME CLASS :94V-0/V-2
- ◆ COLOR: NATURAL
- ◆ UNIT: mm

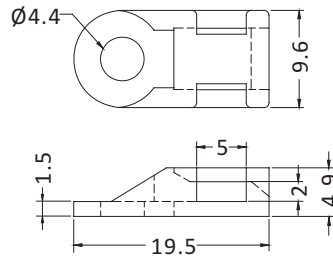

PART NO	PACKAGE
MOSTH1	1000

CABLE TIE MOUNT

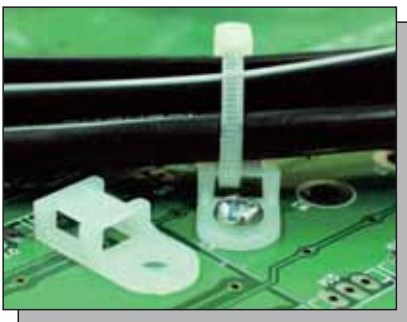

- ◆ MATERIAL: NYLON 66 (UL)
- ◆ FLAME CLASS :94V-0/94V-2
- ◆ COLOR: NATURAL
- ◆ UNIT: mm

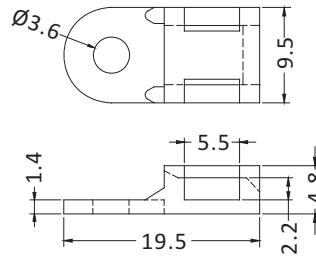

PART NO	PACKAGE
MOSTH3	1000

CABLE TIE MOUNT



- ◆ MATERIAL: NYLON 66 (UL)
- ◆ FLAME CLASS :94V-0/94V-2
- ◆ COLOR: NATURAL
- ◆ UNIT: mm

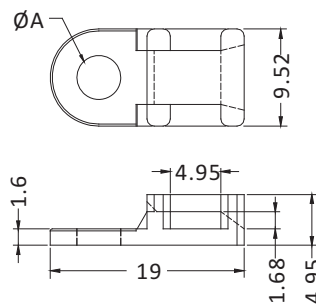

PART NO	A	PACKAGE
MOSTH4	4.3	1000
MOSTH7	6.5	

CABLE TIE MOUNT



- ◆ MATERIAL: NYLON 66 (UL)
- ◆ FLAME CLASS: 94V-2
- ◆ COLOR: NATURAL
- ◆ UNIT: mm

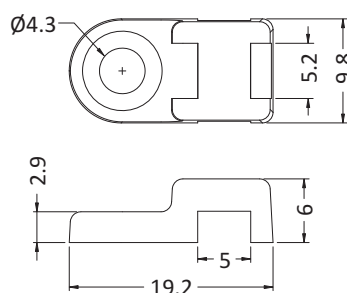

PART NO	PACKAGE
MOSTH5	1000

CABLE TIE MOUNT

- ◆ MATERIAL: NYLON 66 (UL)
- ◆ FLAME CLASS: 94V-2
- ◆ COLOR: NATURAL
- ◆ UNIT: mm

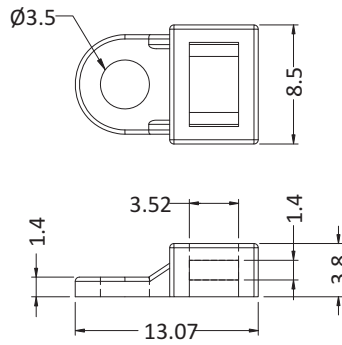

PART NO	PACKAGE
MOSTH6	1000

CABLE TIE MOUNT

- ◆ MATERIAL: NYLON 66 (UL)
- ◆ FLAME CLASS: 94V-2
- ◆ COLOR: NATURAL
- ◆ UNIT: mm

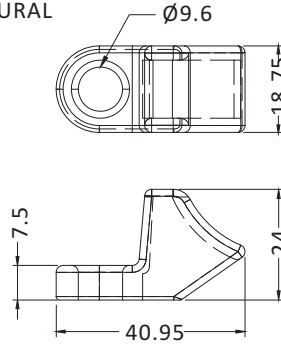

PART NO	PACKAGE
MOSTHMA1	1000

CABLE TIE MOUNT

- ◆ MATERIAL: NYLON 66 (UL)
- ◆ FLAME CLASS :94V-2
- ◆ COLOR: NATURAL
- ◆ UNIT: mm

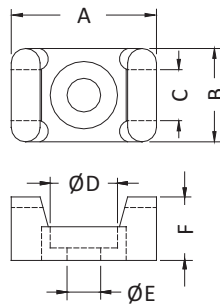
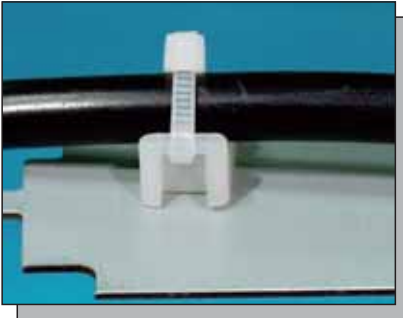

PART NO	A	B	C	D	E	F	PACKAGE
MOSTH2	15.2	9.7	5.2	6.9	3.5	6.6	1000
MOSTH2S	13.3	8.2	3.6	5.9	3.2	5.85	

CABLE TIE MOUNT

- ◆ MATERIAL: NYLON 66 (UL)
- ◆ FLAME CLASS :94V-2
- ◆ COLOR: NATURAL
- ◆ UNIT: mm

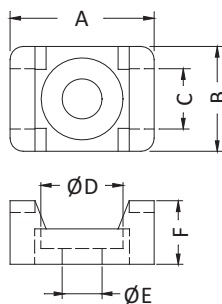

PART NO	A	B	C	D	E	F	PACKAGE
MOSTM2S6	14.9	9.6	5.6	7.8	3.7	7.2	1000
MOSTM2S8	14.9	9.6	5.6	7.8	4.5	7.2	
MOSTM3S8	22.0	16.0	9.2	8.0	4.5	9.6	500
MOSTM3S10	22.0	16.0	9.2	9.6	4.8	9.6	
MOSTM3S25	22.0	16.0	9.2	12.7	6.4	9.6	

CABLE TIE MOUNT

- ◆ MATERIAL: NYLON 66 (UL)
- ◆ FLAME CLASS :94V-2
- ◆ COLOR: NATURAL
- ◆ UNIT: mm

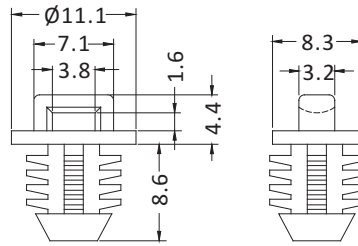

CHASSIS Ø7.9
THICKNESS 6.4mm MIN.

PART NO	PACKAGE
MOSCCMF1	1000

CABLE TIE MOUNT

- ◆ MATERIAL: NYLON 66 (UL)
- ◆ FLAME CLASS :94V-2
- ◆ COLOR: NATURAL/BLACK
- ◆ UNIT: mm

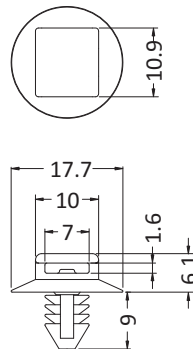

MOUNTING HOLE Ø6
THICKNESS 0.9~3.8

PART NO	PACKAGE
MOSCCMF2	1000

CABLE TIE MOUNT



- ◆ MATERIAL: NYLON 66 (UL)
- ◆ FLAME CLASS: 94V-2
- ◆ COLOR: GRAY
- ◆ UNIT: mm

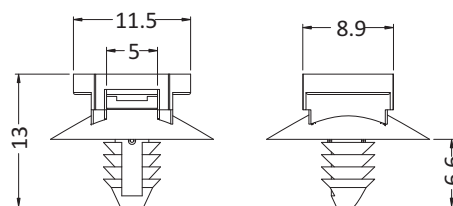

HOLE Ø4.5~5.0
THICKNESS 0.8~7.0

PART NO	PACKAGE
MOSCCMF3	1000

CABLE TIE MOUNT

- ◆ MATERIAL: NYLON 66 (UL)
- ◆ FLAME CLASS :94V-2
- ◆ COLOR:NATURAL
- ◆ UNIT:mm

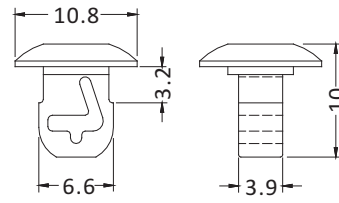
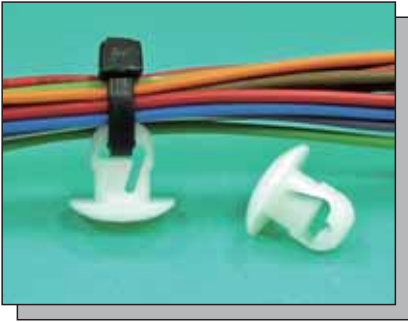

CHASSIS Ø6.4

PART NO	PACKAGE
MOSCCM1	1000

CABLE TIE MOUNT

- ◆ MATERIAL: NYLON 66 (UL)
- ◆ FLAME CLASS :94V-2
- ◆ COLOR:NATURAL
- ◆ UNIT:mm

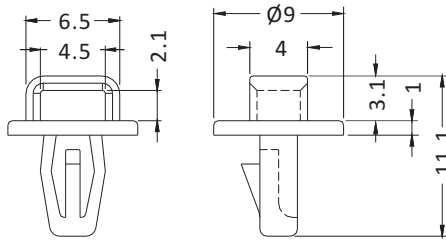

P.C.B Ø4.0
THICKNESS 1.6~2.0

PART NO	PACKAGE
MOSCCMT2	1000

CABLE TIE MOUNT

- ◆ MATERIAL: NYLON 66 (UL)
- ◆ FLAME CLASS :94V-2
- ◆ COLOR:NATURAL
- ◆ UNIT:mm

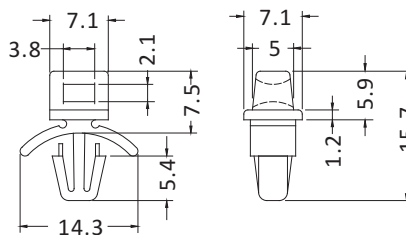

CHASSIS Ø4.8
THICKNESS 0.8~2.0

PART NO	PACKAGE
MOSCCME1	1000

CABLE TIE MOUNT

- ◆ MATERIAL: NYLON 66 (UL)
- ◆ FLAME CLASS :94V-2
- ◆ COLOR: NATURAL
- ◆ UNIT: mm

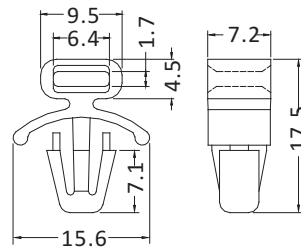
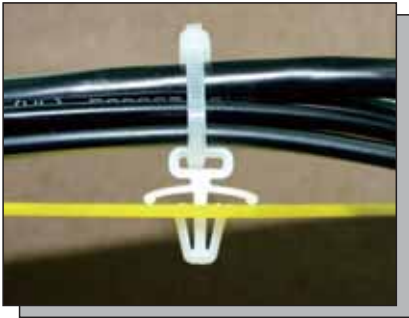

CHASSIS \varnothing 6.4
THICKNESS 1.2~2.8

PART NO	PACKAGE
MOSCCMW1	1000

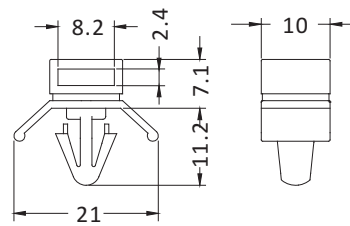
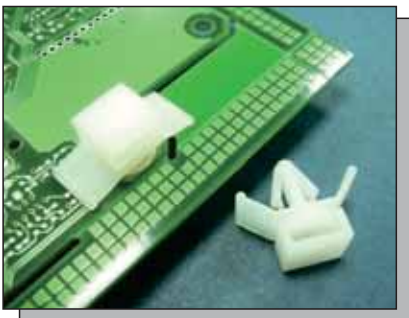

CHASSIS \varnothing 6.2
THICKNESS 0.8~3.2

PART NO	PACKAGE
MOSCCMW2	1000

CABLE TIE MOUNT

- ◆ MATERIAL: NYLON 66 (UL)
- ◆ FLAME CLASS: 94V-2
- ◆ COLOR: NATURAL
- ◆ UNIT: mm

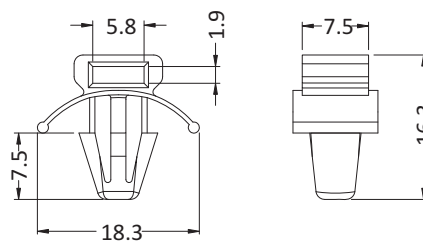

HOLE \varnothing 6.2~6.35
THICKNESS 0.8~3.6

PART NO	PACKAGE
MOSCCMW3	1000

CABLE MOUNT

- ◆ MATERIAL: NYLON 66 (UL)
- ◆ FLAME CLASS :94V-2
- ◆ COLOR: BLACK
- ◆ UNIT: mm

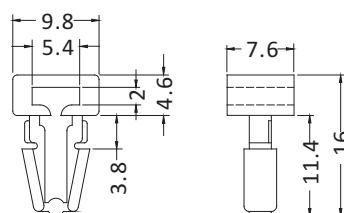

PANEL HOLE DIA 6.4
PANEL THICKNESS 3.17 MAX

PART NO	PACKAGE
MOSCCMV1	1000