

- Adopt thermoplastic crust, compact construction, and Simple installation;
- May install the protecting cap, can against oil and dustproof;
- Hand reset and automatic reset for flexible choice;
- Widely used in Electrical equipment ,automatic machine, communication equipment and instrument, electro motion tool etc.

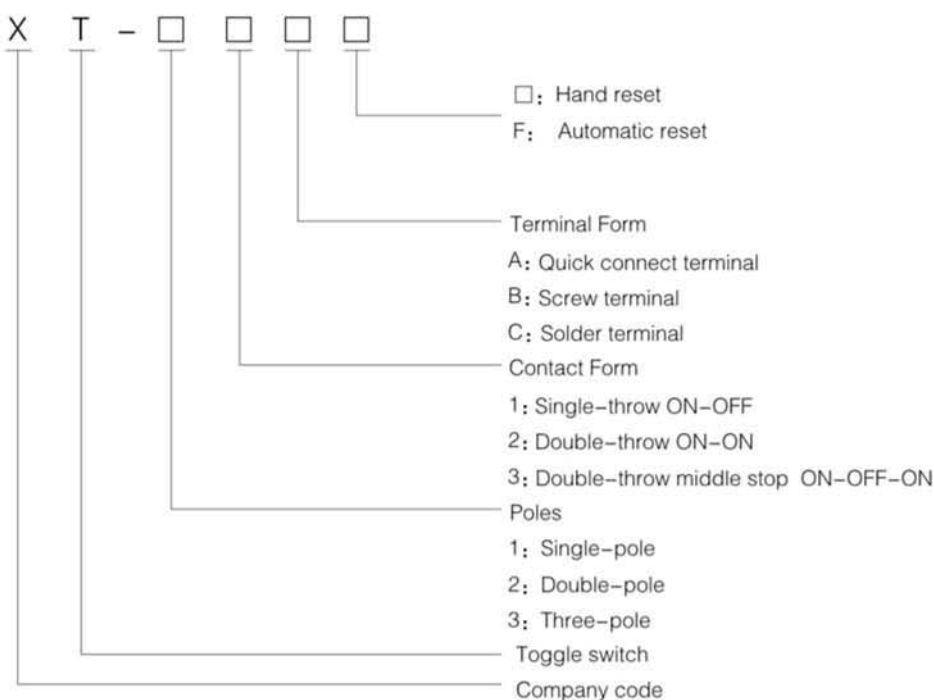

Model & Meanings



Mounting Holes & Product Structure

MMTS



MXT

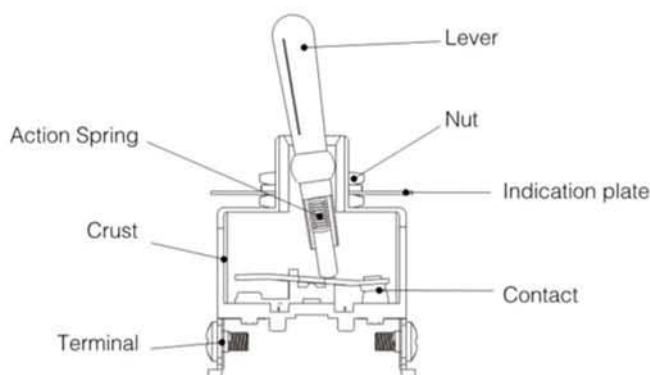
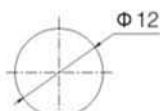

Item	Data	
Rating load	15A/250VAC, 25A/250VAC	MTS: 6A/125,250V
Operation frequency	30times/min	
Insulation resistance	100MΩ (Above) DC500V	
Contact resistance	25mΩ (initial value)	
Withstand voltage	Non-connection wire	1000VAC
	Every terminal	1500VAC
Vibration	Misoperation	10-55Hz Amplitude 1.5mm
Impact	Durable	1000m/s ²
	Misoperation	300m/s ²
Life	Electrical	100,000 above
	Mechanical	500,000above
Protection degree	IP40	
Operating temperature	-25~+80°C	
Operating humidity	<85%	

Terminal Forms

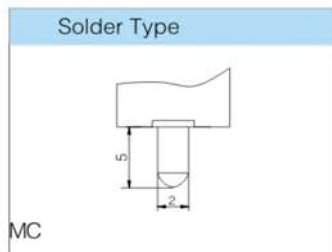
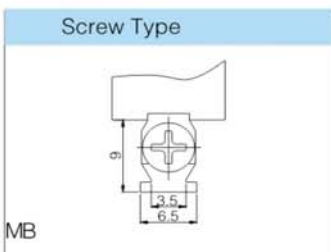
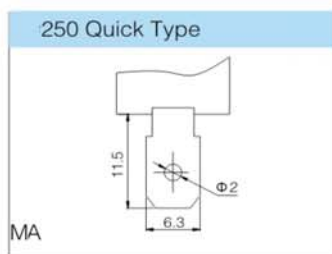
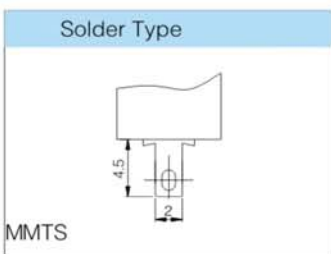

Dimensions

SPDT ON-ON
MMTS-102

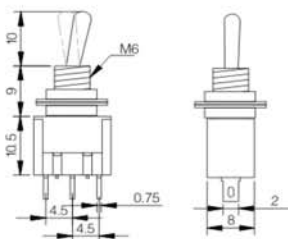

DPDT ON-ON
MMTS-202

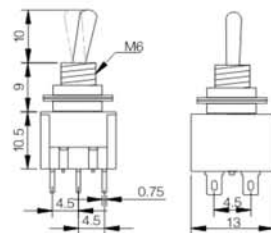

SPDT ON-OFF-ON
MMTS-103

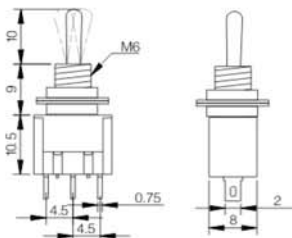

DPDT ON-OFF-ON
MMTS-203

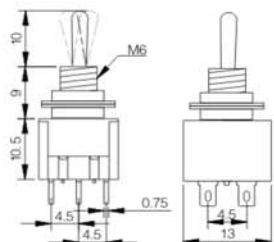

**SPST ON-OFF
MXT-11B**

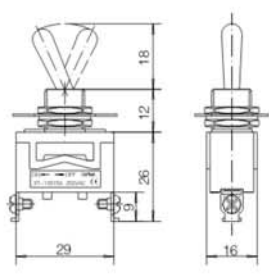

**DPDT ON-OFF-ON
MXT-23B**

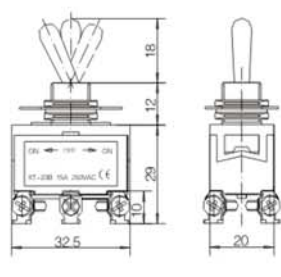

**SPDT ON-ON
MXT-12B**

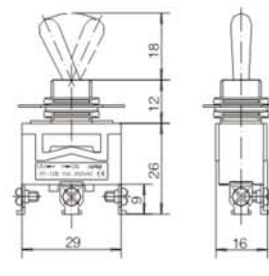

**SPST ON-OFF
MXT-11A**

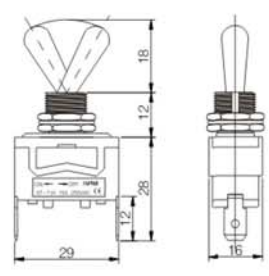

**SPDT ON-OFF-ON
MXT-13B**

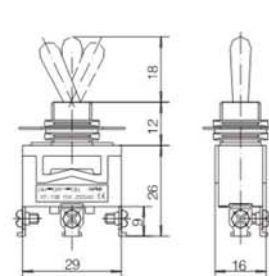

**SPDT ON-ON
MXT-12A**

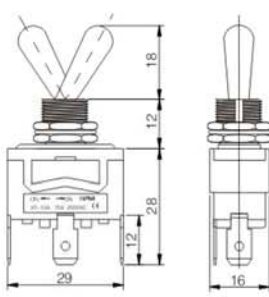

**DPST ON-OFF
MXT-21B**

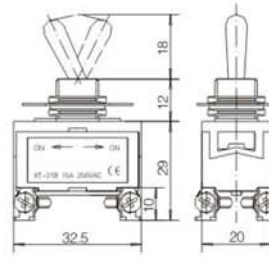

**SPDT ON-OFF-ON
MXT-13A**

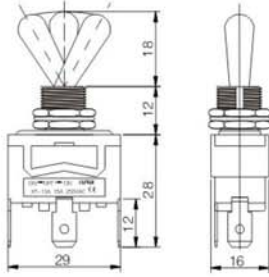

**DPDT ON-ON
MXT-22B**

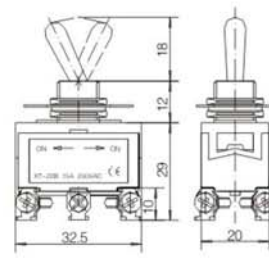

**DPST ON-OFF
MXT-21A**

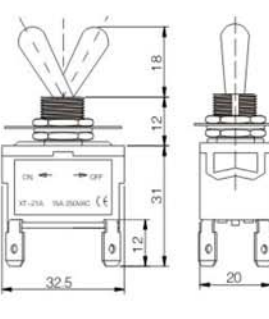

DPDT ON-OFF-ON
MXT-22A

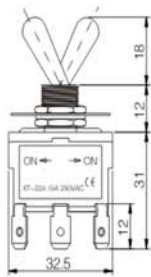

DPDT Auto Reset (ON)-OFF-(ON)
MXT-23BF

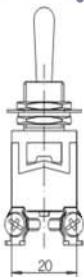
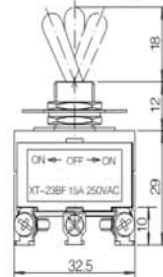

DPDT ON-OFF-ON
MXT-23A

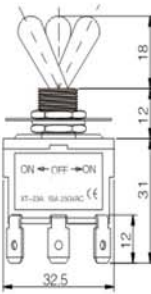

SPST Auto Reset (ON)-OFF
MXT-11AF

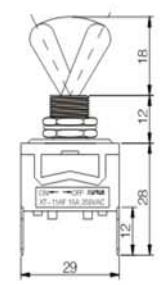

SPST Auto Reset (ON)-OFF
MXT-11BF

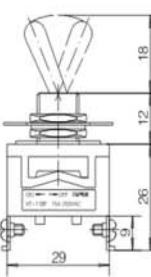

SPDT Auto Reset (ON)-OFF-(ON)
MXT-13AF

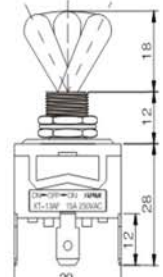

SPDT Auto Reset(ON)-OFF-(ON)
MXT-13BF

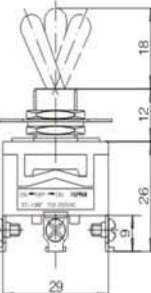

DPST Auto Reset (ON)-OFF
MXT-21AF

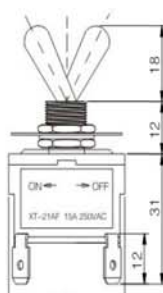

DPST Auto Reset (ON)-OFF
MXT-21BF

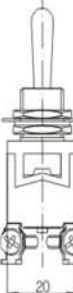
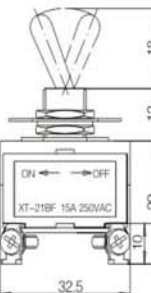

DPDT Auto Reset (ON)-OFF-(ON)
MXT-23AF

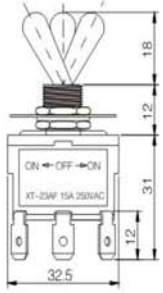

SPST ON-OFF
MXT-11C

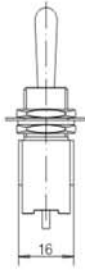
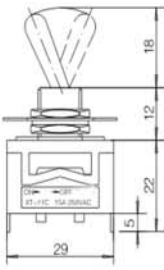

DPDT ON-OFF
MXT-23C

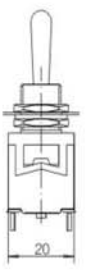
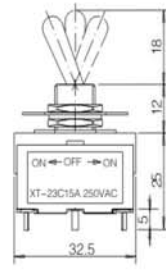

SPDT ON-ON
MXT-12C

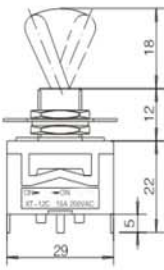

SPST Auto Reset (ON)-OFF
MXT-11CF

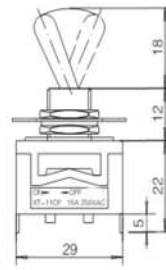

SPDT ON-OFF-ON
MXT-13C

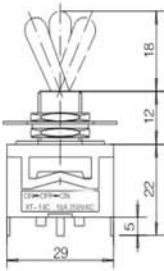

SPDT Auto Reset (ON)-OFF-(ON)
MXT-13CF

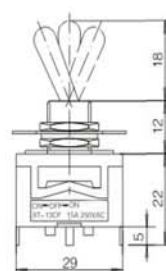

DPST ON-OFF
MXT-21C

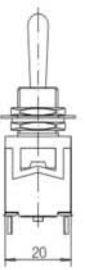
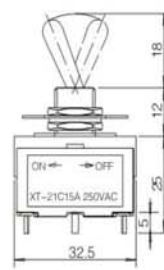

DPST Auto Reset (ON)-OFF
MXT-21CF

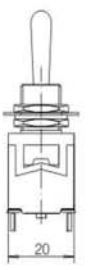
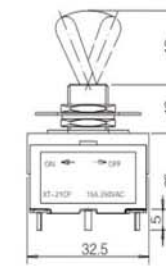

DPDT ON-ON
MXT-22C

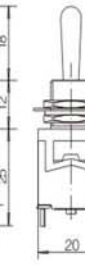
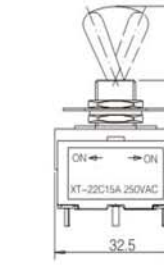

DPDT Auto Reset (ON)-OFF-(ON)
MXT-23CF

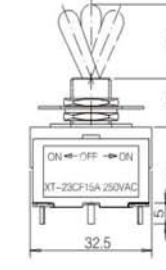

TPST ON-OFF
MXT-31B

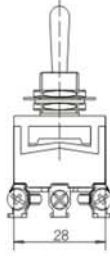
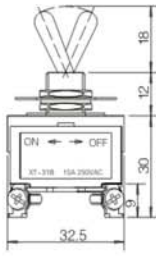

TPST ON-OFF
MXT-31A

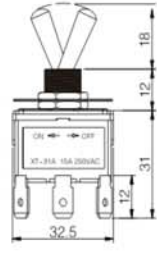

TPDT ON-ON
MXT-32B

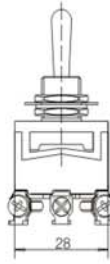
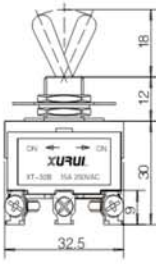

TPDT ON-ON
MXT-32A

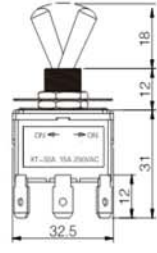

TPDT ON-OFF-ON
MXT-33B

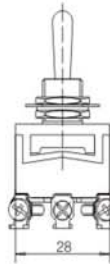
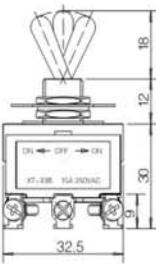

TPDT ON-OFF-ON
MXT-33A

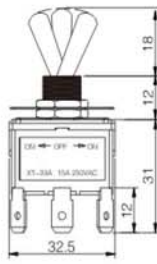

TPST Auto Reset (ON)-OFF
MXT-31BF

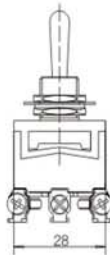
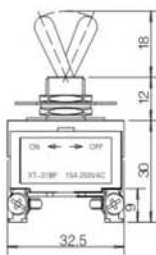

Protecting Cap
MXT-HT

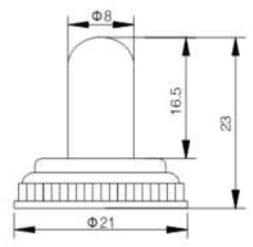

TPDT Auto Reset (ON)-OFF-(ON)
MXT-33BF

